

# Power analyzers and Energy Meters

## Power Analyzer

### Type WM14 96 "Advanced version"

CARLO GAVAZZI



- Protection degree (front): IP65
- 2 digital outputs
- 16 freely configurable alarms with OR/AND logic linkable with up to 2 digital outputs
- RS422/485 serial output (MODBUS-RTU), iFIX SCADA compatibility

- Class 1 (kWh), Class 2 (kvarh)
- Accuracy  $\pm 0.5$  F.S. (current/voltage)
- Power Analyzer
- Instantaneous variables read-out: 3 DGT
- Energies readout: 8+1 DGT
- System variables:  $V_{LL}$ ,  $V_{LN}$ ,  $A_n$ ,  $A_{dmd\ max}$ ,  $VA$ ,  $VA_{dmd}$ ,  $VA_{dmd\ max}$ ,  $W$ ,  $W_{dmd}$ ,  $W_{dmd\ max}$ ,  $var$ ,  $PF$ ,  $Hz$ ,  $ASY$
- Single phase variables:  $V_{LL}$ ,  $V_{LN}$ ,  $V_{LN\ min}$ ,  $V_{LN\ max}$ ,  $A$ ,  $A_{min}$ ,  $A_{max}$ ,  $A_{dmd}$ ,  $VA$ ,  $W$ ,  $W_{dmd}$ ,  $W_{max}$ ,  $var$ ,  $PF$ ,  $PF_{min}$
- Harmonic analysis (FFT) up to the 15<sup>th</sup> harmonic (current and voltage)
- Four quadrant power measurement
- Energy measurements: total and partial kWh and kvarh
- Hour counter (5+2 DGT)
- TRMS meas. of distorted sine waves (voltages/currents)
- Universal power supply: 90 to 260 VAC/DC, 18 to 60 VAC/DC
- Front dimensions: 96x96mm
- Voltage asymmetry, phase sequence, phase loss control

## Product Description

3-phase advanced power analyzer with integrated programming key-pad. Particularly recommended for the measurement of the main electrical variables.

Housing for panel mounting, with RS485 communication port or pulse and/or alarm outputs.

## How to order WM14-96 AV5 3 HR2 S1 AX

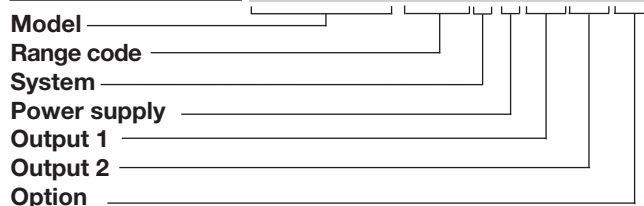

## Type Selection

Range codes	System	Output 1	Output 2
<b>AV5:</b> 380/660V <sub>LL</sub> /1/5(6)AAC V <sub>LN</sub> : 185 V to 460 V V <sub>LL</sub> : 320 V to 800 V <b>AV6:</b> 120/208V <sub>LL</sub> /1/5(6)AAC V <sub>LN</sub> : 45 V to 145 V V <sub>LL</sub> : 78 V to 250 V Phase current: 0.03A to 6A Neutral current: 0.09A to 6A	<b>3 :</b> 1, 2 or 3 phase, balanced/unbalanced load, with or without neutral  <b>Power supply</b> <b>L:</b> 18 to 60 VAC/VDC <b>H:</b> 90 to 260 VAC/VDC	<b>R2:</b> 2-relay outputs <b>O2:</b> 2-open collector outputs	<b>XX:</b> None <b>S1:</b> RS485/RS422 port  <b>Options</b> <b>AX:</b> advanced functions

## Input specifications

Rated inputs	System type: 3	Phase-neutral voltage	$\pm(0.5\% \text{ FS} + 1 \text{ DGT})$
Current	3 (Shunts)	Active and Apparent power,	0.25 to 6A: $\pm(1\% \text{ FS} + 1\text{DGT})$ ; 0.03A to 0.25A: $\pm(1\% \text{ FS} + 5\text{DGT})$
Voltage	4	Reactive power	0.25 to 6A: $\pm(2\% \text{ FS} + 1\text{DGT})$ ; 0.03A to 0.25A: $\pm(2\% \text{ FS} + 5\text{DGT})$
<b>Accuracy</b> (display, RS485) (@25°C $\pm 5^\circ\text{C}$ , R.H. $\leq 60\%$ )	with CT=1 and VT=1 AV5: 1150W-VA-var, FS:230V <sub>LN</sub> , 400V <sub>LL</sub> ; AV6: 285W-VA-var, FS:57V <sub>LN</sub> , 100V <sub>LL</sub>	Active energy	Class 1 (I start up: 30mA)
Current	0.25 to 6A: $\pm(0.5\% \text{ FS} + 1\text{DGT})$ 0.03A to 0.25A: $\pm(0.5\% \text{ FS} + 7\text{DGT})$	Reactive energy	Class 2 (I start up: 30mA)
Neutral current	0.25 to 6A: $\pm(1.5\% \text{ FS} + 1\text{DGT})$ 0.09A to 0.25A: $\pm(1.5\% \text{ FS} + 7\text{DGT})$	Frequency	$\pm 0.1\text{Hz}$ (48 to 62Hz)
Phase-phase voltage	$\pm(1.5\% \text{ FS} + 1 \text{ DGT})$	Harmonic distortion	$\pm 3\% \text{ F.S.}$ (up to 15 <sup>th</sup> harmonic) (F.S.: 100%)



## Input specifications (cont.)

<b>Additional errors</b>		<b>Measurements</b>	
Humidity	≤0.3% FS, 60% to 90% RH	Type	Current, voltage, power, power factor, frequency TRMS measurement of distorted waves.
<b>Temperature drift</b>	≤ 200ppm/°C	Coupling type	Direct
<b>Sampling rate</b>	1600 samples/s @ 50Hz 1900 samples/s @ 60Hz	Crest factor	< 3, max 10A peak
<b>Display refresh time</b>	200ms (FFT off) 500ms (FFT on)	<b>Input impedance</b>	
<b>Display</b>		380/660V <sub>L-L</sub> (AV5)	1.6 MΩ ±5%
Type	LED, 14mm	120/208V <sub>L-L</sub> (AV6)	1.6 MΩ ±5%
Read-out for instant. var.	3x3 DGT	Current	≤ 0.02Ω
Read-out for energies	3+3+3 DGT (Max indication: 999 999 99.9)	<b>Frequency</b>	48 to 62 Hz
Read-out for hour counter	1+3+3 DGT (Max. indication: 9 999 9.99)	<b>Overload protection</b>	(max values)
		Continuous: voltage/current	AV5: 460V <sub>LN</sub> , 800V <sub>LL</sub> /6A AV6: 145V <sub>LN</sub> , 250V <sub>LL</sub> /6A
		For 500ms: voltage/current	AV5: 800V <sub>LN</sub> , 1380V <sub>LL</sub> /36A AV6: 240V <sub>LN</sub> , 416V <sub>LL</sub> /36A

## Output Specifications

<b>Digital outputs</b>		<b>Relay outputs</b>	
Pulse type		Purpose	For alarm outputs or for pulse outputs
Number of outputs	Up to 2	Type	Relay, SPST type
Type	Programmable from 0.01 to 500 pulses per kWh/kvarh	Insulation	AC 1-5A @ 250VAC DC 12-5A @ 24VDC AC 15-1.5A @ 250VAC DC 13-1.5A @ 24VDC 4000 V <sub>RMS</sub> output to measuring input, 4000 V <sub>RMS</sub> output to supply input.
Alarm type		<b>RS422/RS485</b>	(on request)
Number of outputs	Up to 2, independent	Connections	Multidrop bidirectional (static and dynamic variables)
Alarm modes	Up alarm, down alarm, in window alarm, out window alarm. Start-up deactivation function available for all kinds of alarm. All of them connectable on all variables (see the table "List of the variables that can be connected to")	Addresses	2 or 4 wires, max. distance 1200m, termination directly on the instrument
Set-point adjustment	From 0 to 100% of the display scale	Protocol	From 1 to 255, selectable
Hysteresis	From 0 to full scale	Data (bidirectional)	MODBUS/JBUS (RTU)
On-time delay	0 to 255s	Dynamic (reading only)	
Output status	Selectable; normally de-energized and normally energized	Static (writing only)	System and phase variables: see table "List of variables..."
Min. response time	≤400ms, filters excluded, With FFT off; ≤1s, with FFT on. Set-point on-time delay: "0 s"	Data format	All the configuration parameters.
<b>Note</b>	The 2 digital outputs can also work as pulse output and alarm output.	Baud-rate	1 start bit, 8 data bit, no parity, 1 stop bit
<b>Static outputs</b>		Insulation	4800, 9600, 19200, 38400bits/s
Purpose	For pulse outputs or for alarm outputs		By means of optocouplers, 4000 V <sub>RMS</sub> output to measuring input 4000 V <sub>RMS</sub> output to supply input
Signal	V <sub>ON</sub> 1.2 VDC/ max. 100 mA V <sub>OFF</sub> 30 VDC max.		
Insulation	By means of optocouplers, 4000 V <sub>RMS</sub> output to measuring inputs, 4000 V <sub>RMS</sub> output to power supply input.		

## Software functions

<b>Password</b>  1 <sup>st</sup> level  2 <sup>nd</sup> level	Numeric code of max. 3 digits; 2 protection levels of the programming data Password "0", no protection Password from 1 to 999, all data are protected	<b>Alarms</b> Working mode	"OR" or "AND" or "OR+AND" functions (see "Alarm parameter and logic" page). Freely programmable on up to 16 total alarms (out1+out2). The alarms can be connected to any variables available in the table "List of the variables that can be connected to"
<b>System selection</b> System 3, unbalanced  System 3, balanced	3-phase (3-wire, 4-wire) 3-phase ARON 2-phase (3-wire) 3-phase (3-wire, 4-wire) 3-phase (3-wire) "1CT+1VT" 3-phase (3-wire) "1CT+3VT" 1-phase (2-wire)	<b>Reset</b>	By means of keypad: The following kinds of reset are available: - all values stored as "dmd max": Idmd max, Wdmd max, VAdmd max - all values stored as "max": A <sub>1</sub> , A <sub>2</sub> , A <sub>3</sub> , WL <sub>1</sub> , WL <sub>2</sub> , WL <sub>3</sub> , VL <sub>1</sub> , VL <sub>2</sub> , VL <sub>3</sub> , and as "Min": PF <sub>1</sub> , PF <sub>2</sub> , PF <sub>3</sub> , A <sub>1</sub> , A <sub>2</sub> , A <sub>3</sub> , VL <sub>1</sub> , VL <sub>2</sub> , VL <sub>3</sub> . - Only the kWh and kvarh partial counters - Both the kWh and kvarh total and partial counters - the hour counter.
<b>Transformer ratio</b> CT VT/PT	1 to 60000 1.0 to 6000.0		
<b>Filter</b> Operating range  Filtering coefficient Filter action	0 to 100% of the input display scale 1 to 32 Measurements, alarms, serial output (fundamental variables: V, A, W and their derived ones).		
<b>Displaying</b>	Up to 3 variables per page See table "Display pages"		



## Power Supply Specifications

### AC/DC voltage

90 to 260VAC/DC  
16 to 60VAC/DC

### Power consumption

AC: 6 VA  
DC: 3.5 W

## General Specifications

<b>Operating temperature</b>	0° to +50°C (32° to 122°F) (RH < 90% non condensing)	<b>Immunity</b>	EN61000-6-2 industrial environment.
<b>Storage temperature</b>	-10° to +60°C (14° to 140°F) (RH < 90% non condensing)	<b>Pulse voltage (1.2/50µs)</b>	EN61000-4-5
<b>Overvoltage category</b>	Cat. III (IEC 60664, EN60664)	<b>Safety standards</b>	IEC60664, IEC61010-1 EN60664, EN61010-1
<b>Insulation (for 1 minute)</b>	4kVAC <sub>RMS</sub> between measuring inputs and power supply. 4kVAC/DC @ I ≤ 3mA between measuring inputs and RS485. 4kVAC <sub>RMS</sub> between power supply and RS485.	<b>Approvals</b>	CE
<b>Dielectric strength</b>	4kVAC <sub>RMS</sub> (for 1 min)	<b>Connections 5(6) A</b> Max cable cross sect. area	Screw-type 2.5 mm <sup>2</sup>
<b>EMC</b>		<b>Housing</b> Dimensions (WxHxD) Material	96 x 96 x 63 mm ABS self-extinguishing: UL 94 V-0
Emissions	EN61000-6-3 residential environment, commerce and light industry	<b>Mounting</b>	Panel
		<b>Protection degree</b>	Front: IP65 (standard) Connections: IP20
		<b>Weight</b>	Approx. 400 g (pack. incl.)

## Insulation between inputs and outputs

	Measuring Inputs V	Measuring Inputs A	Relay outputs	Open collector outputs	Communication Port	Power Supply 90-260VAC/DC	Power Supply 18-60VAC/DC
Measuring Inputs V	-	-	4kV	4kV	2.5kV	4kV	4kV
Measuring Inputs A	-	-	4kV	4kV	2.5kV	4kV	4kV
Relay outputs	4kV	4kV	-	-	2.5kV	4kV	4kV
Open col. out- puts	4kV	4kV	-	-	2.5kV	4kV	4kV
Communication Port	2.5kV	2.5kV	-	-	-	4kV	4kV
90-260VAC/DC	4kV	4kV	4kV	4kV	4kV	-	-
18-60VAC/DC	4kV	4kV	4kV	4kV	4kV	-	-

**NOTE:** In case of fault of first insulation the current from the measuring inputs to the ground is lower than 2 mA.

## List of the variables that can be connected to:

- RS485/RS422 communication port
- Alarm outputs (“max / min” variable, “energies” and “hour counter” excluded)
- Pulse outputs (only “energies”)

No	Variable	1-phase system	2-phase system	3-ph. 4-wire balanced sys.	3-ph. 4-wire unbal. sys.	3 ph. 3-wire bal. sys.	3 ph. 3-wire unbal. sys.	Notes
1	V L1	x	x	x	x	o	o	◆ ★
2	V L2	o	x	x	x	o	o	◆ ★
3	V L3	o	o	x	x	o	o	◆ ★
4	V L-N sys	o	x	x	x	o	o	Sys = system
5	V L1-2	o	x	x	x	x	x	
6	V L2-3	o	x	x	x	x	x	
7	V L3-1	o	o	x	x	x	x	
8	V L-L sys	o	x	x	x	x	x	Sys = system
9	A L1	x	x	x	x	x	x	◆ ★
10	A L2	o	x	x	x	x	x	◆ ★
11	A L3	o	o	x	x	x	x	◆ ★
12	An	o	x	x	x	x	x	
13	W L1	x	x	x	x	o	o	◆
14	W L2	o	x	x	x	o	o	◆
16	W L3	o	o	x	x	o	o	◆
17	W sys	o	x	x	x	x	x	Sys = system
18	var L1	x	x	x	x	o	o	
19	var L2	o	x	x	x	o	o	
20	var L3	o	o	x	x	o	o	
21	var sys	o	x	x	x	x	x	Sys = system
22	VA L1	x	x	x	x	o	o	
23	VA L2	o	x	x	x	o	o	
24	VA L3	o	o	x	x	o	o	
25	VA sys	o	x	x	x	x	x	Sys = system
26	PF L1	x	x	x	x	o	o	★
27	PF L2	o	x	x	x	o	o	★
28	PF L3	o	o	x	x	o	o	★
29	PF sys	o	x	x	x	x	x	Sys = system
30	Hz	x	x	x	x	x	x	
31	Phase seq.	o	x	x	x	x	x	
32	ASY L-N	o	x	x	x	x	x	
33	ASY L-L	o	x	x	x	x	x	
34	Phase loss	o	x	x	x	x	x	
35	VA sys dmd	x	x	x	x	x	x	Sys = system ◆○
36	W sys dmd	x	x	x	x	x	x	Sys = system ◆○
37	A L1 dmd	x	x	x	x	x	x	◆
38	A L2 dmd	o	x	x	x	x	x	◆
39	A L3 dmd	o	o	x	x	x	x	◆
40	A L dmd	x	x	x	x	x	x	□
41	A L1 THD	x	x	x	x	x	x	
42	A L2 THD	o	x	x	x	x	x	
43	A L3 THD	o	o	x	x	x	x	
44	V L1 THD	x	x	x	x	x	x	
45	V L2 THD	o	x	x	x	x	x	
46	V L3 THD	o	o	x	x	x	x	
47	kWh	x	x	x	x	x	x	Total and partial
48	kvarh	x	x	x	x	x	x	Total and partial
49	hours	x	x	x	x	x	x	

(x) = available (o) = not available

◆ These variables are available also as MAX detection and data storage (on EEPROM at power down).

★ These variables are available also as MIN detection and data storage (on EEPROM at power down).

□ Highest value among the 3-phase.

○ Alarm available only on the consumed power (+).



## Alarm parameters and logic



- Block enable.
- Controlled variable (VLN, ...).
- Alarm type (up, down, window int, window ext).
- Activation function.
- ON set-point.
- OFF set-point.
- ON delay.
- Logical function (AND, OR).
- Digital output (1, 2).

A, B, C... up to 16 parameter control blocks.

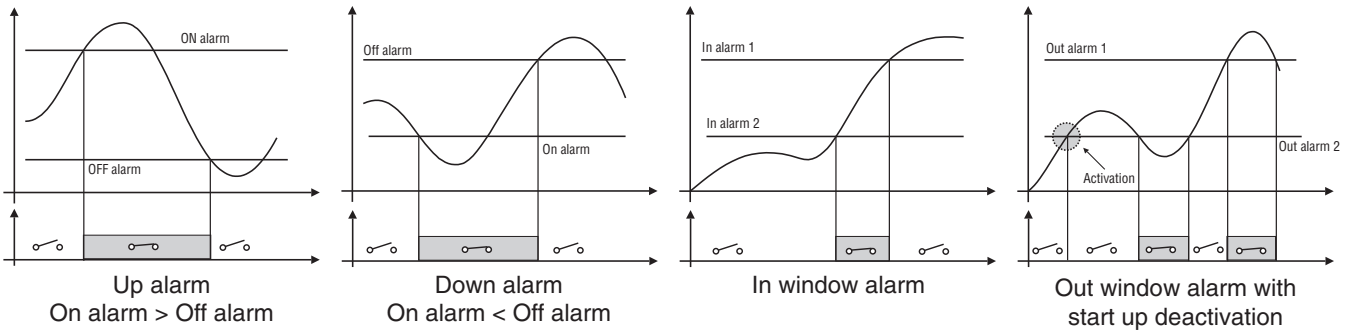

**Note:** any alarm working mode can be linked to the "Start-up deactivation" function which disables only the first alarm after power on of the instrument.

## AND/OR logical alarm examples:

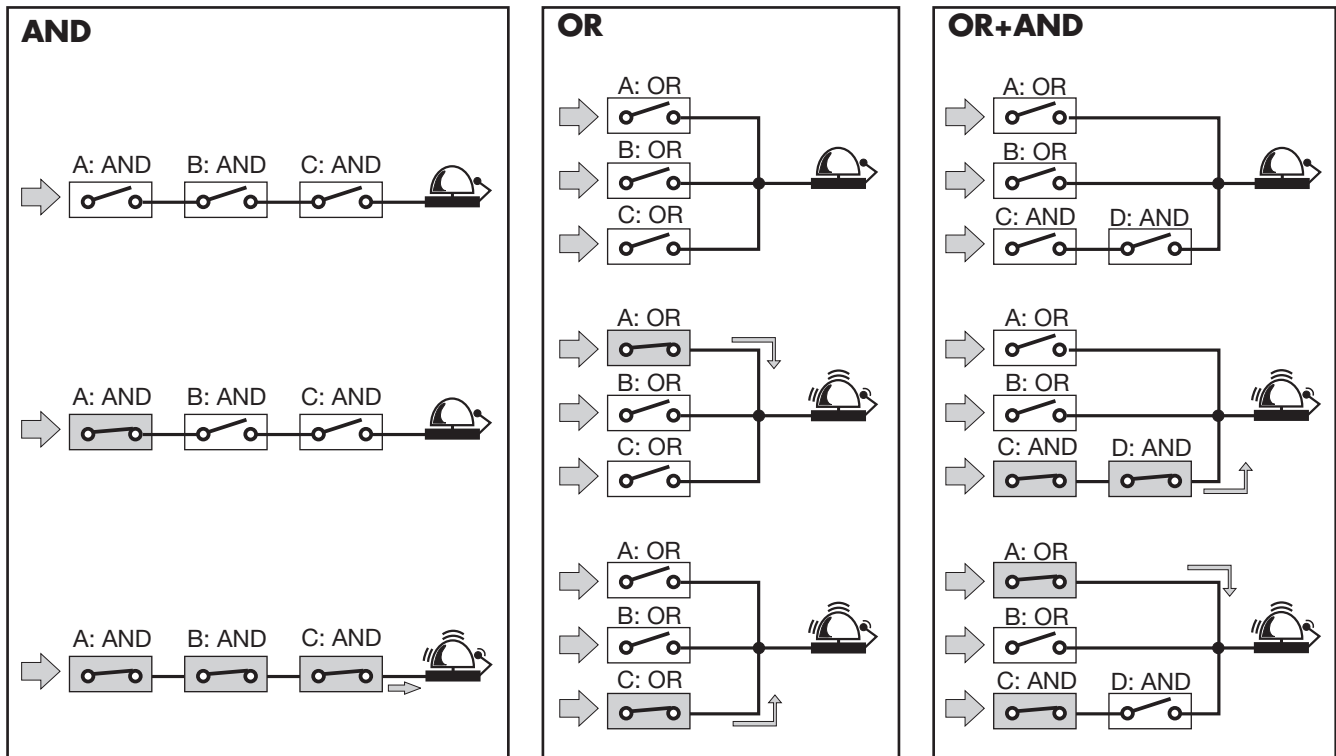

## Display pages

### Display variables in 3-phase systems (in a 3-phase system with neutral)

No	1 <sup>st</sup> variable	2 <sup>nd</sup> variable	3 <sup>rd</sup> variable	Note
1	%	"ASY"	"L N"	Phase to neutral asymmetry
2	V L1	V L2	V L3	
3	V LN sys		PF sys	Sys = system
4	V LL sys		PF sys	Decimal point blinking on the right of the display
5	V L1 2	V L2 3	V L3 1	Decimal point blinking on the right of the display
6	%	"ASY"	"L L"	Phase to phase asymmetry
7	"PH"	"SEq"	1 2 3 / 1 3 2	Phase sequence
8	A L1	A L2	A L3	
9	A dmd L1	A dmd L2	A dmd L3	dmd = demand (integration time selectable from 1 to 30 minutes)
10	An	"n"	Hz	An= neutral current
11	W L1	W L2	W L3	
12	W dmd L1	W dmd L2	W dmd L3	dmd = demand (integration time selectable from 1 to 30 minutes)
13	PF L1	PF L2	PF L3	
14	var L1	var L2	var L3	
15	VA L1	VA L2	VA L3	
16	VA sys	W sys	var sys	
17	VA dmd sys	W dmd sys	Hz	dmd = demand (integration time selectable from 1 to 30 minutes)
18	V max L1	V max L2	V max L3	Max value of phase to neutral voltage
19	V min L1	V min L2	V min L3	Min value of phase to neutral voltage
20	A max L1	A max L2	A max L3	Max value of current
21	A min L1	A min L2	A min L3	Min value of current
22	W max L1	W max L2	W max L3	Max value of W
23	PF min L1	PF min L2	PF min L3	Min value of PF
24	VA dmd sys max	W dmd sys max	"H"	Max system dmd
25	A dmd max		"H"	Highest value among the 3-phase
26	V L1 THD	V L2 THD	V L3 THD	
27	A L1 THD	A L2 THD	A L3 THD	
28	h (MSD)	h	h (LSD)	Hour counter
29	kvarh (MSD)	kvarh	kvarh (LSD)	Partial counter
30	kWh (MSD)	kWh	kWh (LSD)	Partial counter
31	kvarh (MSD)	kvarh	kvarh (LSD)	Total counter
32	kWh (MSD)	kWh	kWh (LSD)	Total counter

MSD: most significant digit  
LSD: least significant digit

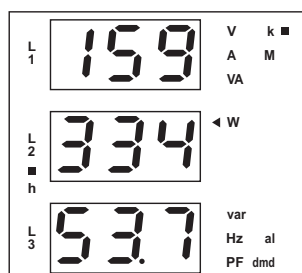

#### 1) Example of kWh visualization:

This example is showing 15 933 453.7 kWh

#### 2) Example of kvarh visualization:

This example is showing 3 553 944.9 kvarh

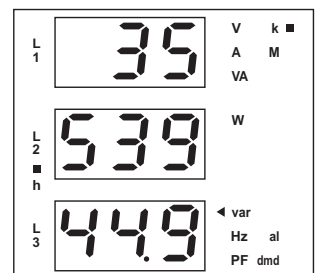





Waveform of the signals that can be measured

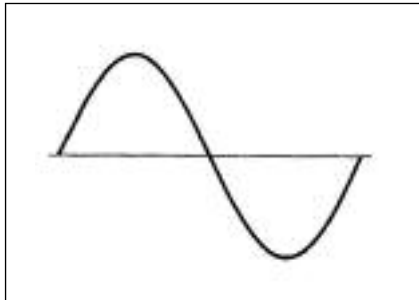

**Figure A**  
**Sine wave, undistorted**  
Fundamental content 100%  
Harmonic content 0%  
 $A_{rms} = 1.1107 | \bar{A} |$

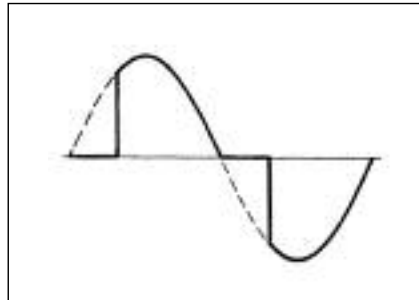

**Figure B**  
**Sine wave, indented**  
Fundamental content 10...100%  
Harmonic content 0...90%  
Frequency spectrum: 3rd to 16th harmonic  
Additional error: <1% FS

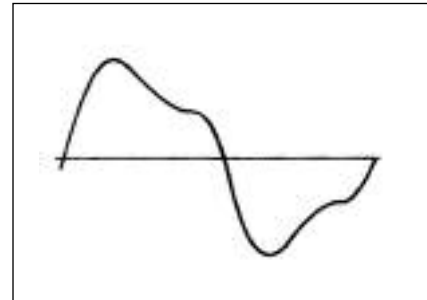

**Figure C**  
**Sine wave, distorted**  
Fundamental content 70...90%  
Harmonic content 10...30%  
Frequency spectrum: 3rd to 16th harmonic  
Additional error: <0.5% FS

Accuracy

Wh, accuracy (RDG) depending on the current

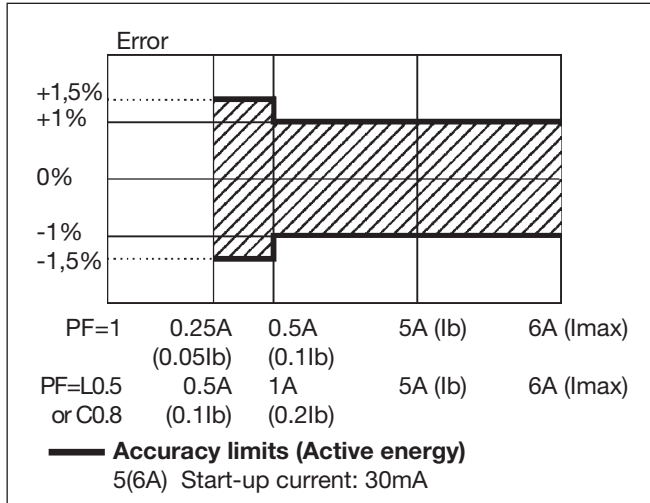

varh, accuracy (RDG) depending on the current

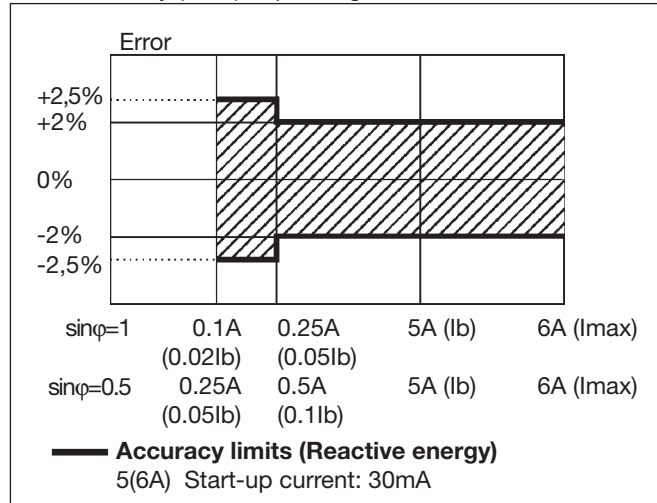

Used calculation formulas

Phase variables

Instantaneous effective voltage

$$V_{IN} = \sqrt{\frac{1}{n} \cdot \sum_1^n (V_{INi})^2}$$

Instantaneous active power

$$W_1 = \frac{1}{n} \cdot \sum_1^n (V_{INi}) \cdot (A_1)_i$$

Instantaneous power factor

$$\cos\phi_1 = \frac{W_1}{VA_1}$$

Instantaneous effective current

$$A_1 = \sqrt{\frac{1}{n} \cdot \sum_1^n (A_1)_i^2}$$

Instantaneous apparent power

$$VA_1 = V_{IN} \cdot A_1$$

Instantaneous reactive power

$$VAR_1 = \sqrt{(VA_1)^2 - (W_1)^2}$$

System variables

Equivalent three-phase voltage

$$V_{\Sigma} = \frac{V_{12} + V_{23} + V_{31}}{3}$$

Voltage asymmetry

$$ASY_{LL} = \frac{(V_{LLmax} - V_{LLmin})}{V_{LL\Sigma}}$$

$$ASY_{LN} = \frac{(V_{LNmax} - V_{LNmin})}{V_{LN\Sigma}}$$

Three-phase reactive power

$$VAR_{\Sigma} = (VAR_1 + VAR_2 + VAR_3)$$

Neutral current

$$An = \bar{A}_{L1} + \bar{A}_{L2} + \bar{A}_{L3}$$

Three-phase active power

$$W_{\Sigma} = W_1 + W_2 + W_3$$

Three-phase apparent power

$$VA_{\Sigma} = \sqrt{W_{\Sigma}^2 + VAR_{\Sigma}^2}$$

Three-phase power factor

$$\cos\phi_{\Sigma} = \frac{W_{\Sigma}}{VA_{\Sigma}} \quad (\text{TPF})$$

Energy metering

$$kWh_i = \int_{t_1}^{t_2} P_i(t) dt \approx \Delta t \sum_{n_1}^{n_2} P_{i,n}$$

$$kVarh_i = \int_{t_1}^{t_2} Q_i(t) dt \approx \Delta t \sum_{n_1}^{n_2} Q_{i,n}$$

Where:

i= considered phase (L1, L2 or L3)  
P= active power; Q= reactive power;  
t<sub>1</sub>, t<sub>2</sub> =starting and ending time points of consumption recording; n= time unit; Δt= time interval between two successive power consumptions;  
n<sub>1</sub>, n<sub>2</sub> = starting and ending discrete time points of consumption recording





## Harmonic Analysis

Analysis principle	FFT	Display of harmonic values	THD %
<b>Harmonic measurement</b>		<b>Others</b>	
Current	Up to 15th harmonic		The harmonic distortion can be measured in both 3-wire or 4-wire systems.
Voltage	Up to 15th harmonic		
<b>Type of harmonics</b>	THD (V.L1) THD (V.L2) THD (V.L3) THD (A.L1) THD (A.L2) THD (A.L3)		

## Wiring diagrams

When the CT is connected to earth, a leakage current from 0 to 1.8mA max is generated, whose value depends on the input impedance values of the instrument, on the type of connection and on the line voltage measured by the instrument.

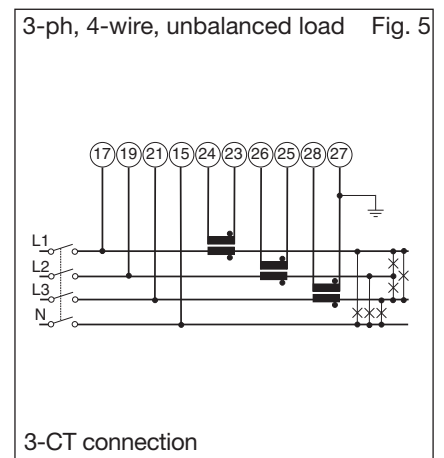
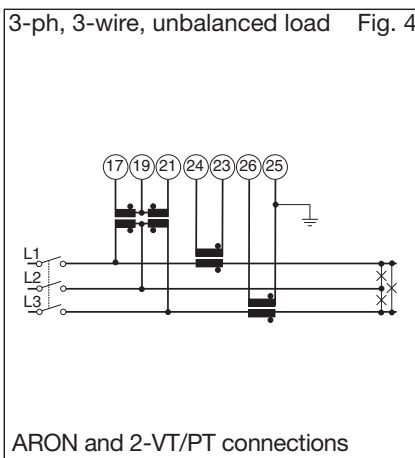
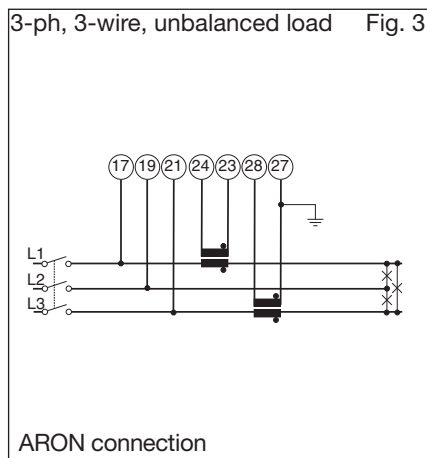
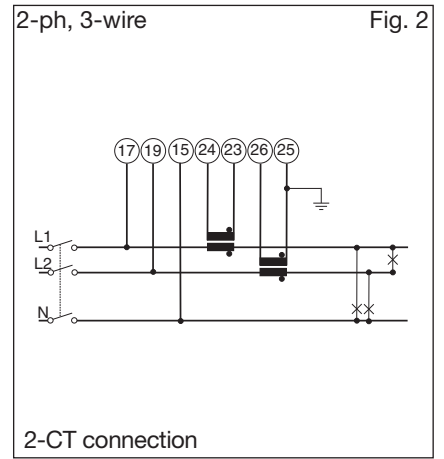
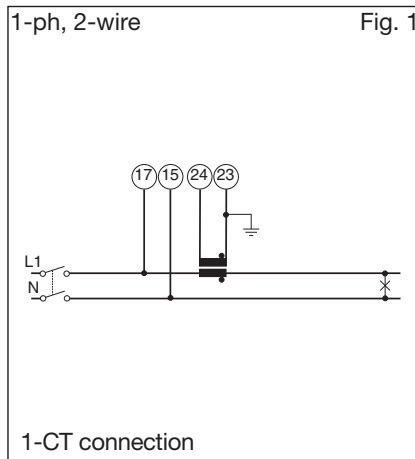
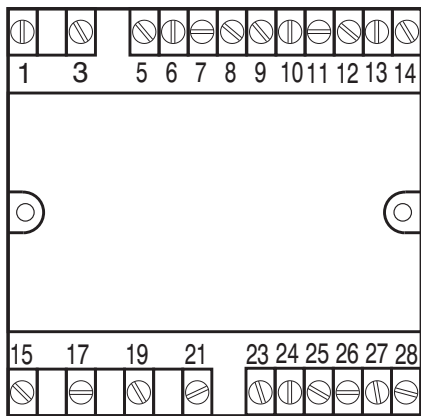

**NOTE:** the current inputs can be connected to the mains ONLY by means of current transformers. The direct connection is not allowed.

## Wiring diagrams

When the CT is connected to earth, a leakage current from 0 to 1.8mA max is generated, whose value depends on the input impedance values of the instrument, on the type of connection and on the line voltage measured by the instrument.

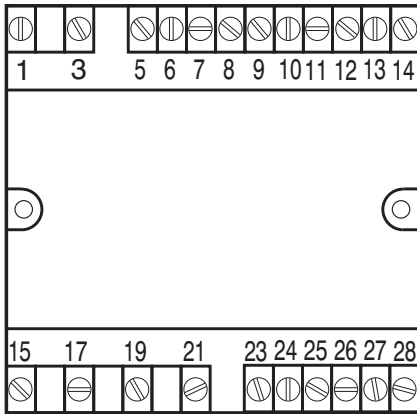

3-ph, 4-wire, unbalanced load Fig. 6

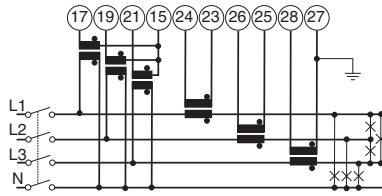

3-CT and 3-VT/PT connections

3-ph, 3-wire, unbalanced load Fig. 7

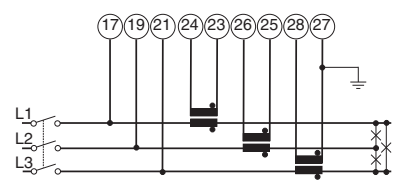

3-CT connection

3-ph, 3-wire, unbalanced load Fig. 8

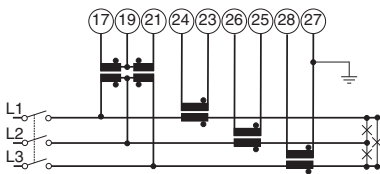

3-CT and 2-VT/PT connections

3-ph, 3-wire, balanced load Fig. 9

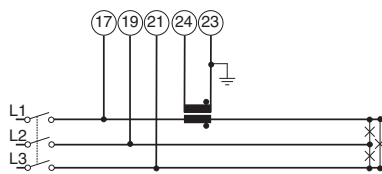

1-CT connection

3-ph, 4-wire balanced load Fig. 10

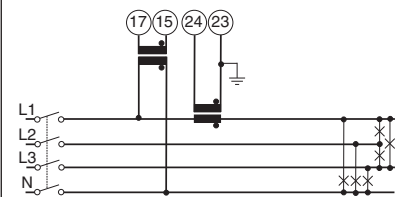

1-CT and 1-VT/PT connections

3-ph, 4-wire, balanced load Fig. 11

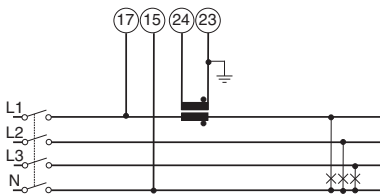

1-CT connection

Fig. 12

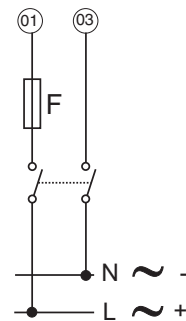

Power supply connection

**NOTE:** the current inputs can be connected to the mains **ONLY** by means of current transformers. The direct connection is not allowed.

## Output connections

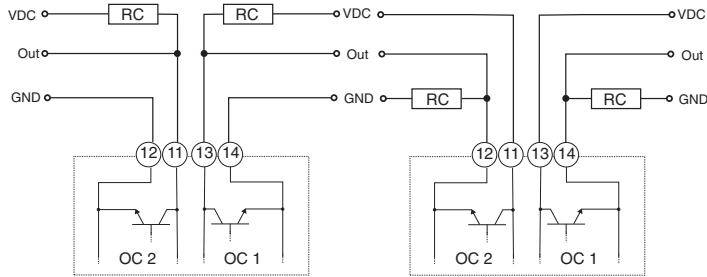

Fig. 13

Fig. 14

**Open collector outputs:** The load resistance (Rc) must be designed so that the closed contact current is lower than 100mA; the VDC voltage must be lower than or equal to 30V. VDC: external power supply voltage. Out: positive output contact (open collector transistor). GND: ground output contact (open collector transistor).

Relay out.

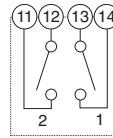

Fig. 15

RS485 port



Fig. 16

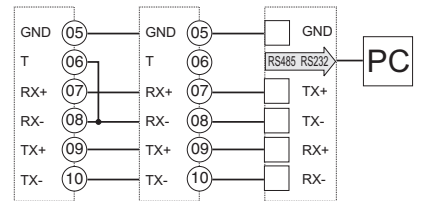
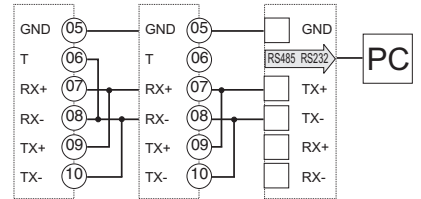
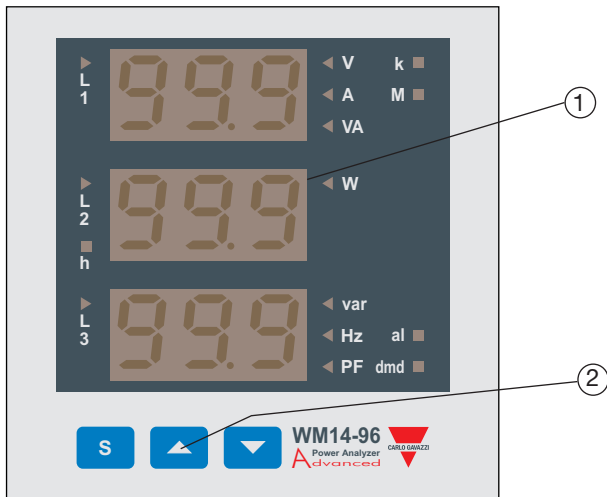

Fig. 17

## Front Panel Description



**1. Display**

LED-type with alphanumeric indications to:  
- display configuration parameters;  
- display all the measured variables.

**2. Key-pad**

To program the configuration parameters and the display of the variables.



Key to enter programming and confirm selections;



Keys to:

- programme values;
- select functions;
- display measuring pages.

## Dimensions and Panel Cut-out

