

Photoelectrics Through-beam, Transistor Output Type PA12B.T20..

CARLO GAVAZZI



- Elevators, Escalators and Entrance control
- Range 20 m
- Modulated, infrared light
- Supply voltage: 10 to 30 VDC
- Output: 100 mA, NPN or PNP type
- Make or break switching
- Protection: reverse polarity, short circuit, transients
- Cable versions with or without connector
- Emitter mute and power adjustment
- High neighbour immunity, 3-codes



Product Description

The PA12BNT. is a through beam sensor set specially designed for Elevators, Escalators, Entrance control to meet the requirements in the door market. The housing is very robust and is known for its high long term reliability mute. The emitter

has a mute input to turn it off for evaluation of the sensor function. The emitter and receivers can be delivered in 3 different codes on order to improve neighbour immunity. Available in 10-30 VDC version.

Ordering Key

PA12B1T20NO-C2

Type	_____
Housing style	_____
Housing size	_____
Housing material	_____
Sensor code	_____
Detection principle	_____
Sensing distance	_____
Output type	_____
Output configuration	_____
Connection type	_____
Cable connector	_____

Type Selection

Housing diameter	Range S _n	Con-nec-tor	Ordering no. Receiver NPN, NO	Ordering no. Receiver NPN, NC	Ordering no. Receiver PNP, NO	Ordering no. Receiver PNP, NC	Ordering no. Emitter
M12 mm Code 1	20 m	NO	PA12B1T20NO	PA12B1T20NC	PA12B1T20PO	PA12B1T20PC	PA12B1T20
M12 mm Code 2	20 m	NO	PA12B2T20NO	PA12B2T20NC	PA12B2T20PO	PA12B2T20PC	PA12B2T20
M12 mm Code 3	20 m	NO	PA12B3T20NO	PA12B3T20NC	PA12B3T20PO	PA12B3T20PC	PA12B3T20
M12 mm Code 1	20 m	YES	PA12B1T20NO-C2	PA12B1T20NC-C2	PA12B1T20PO-C2	PA12B1T20NC-C2	PA12B1T20-C2
M12 mm Code 2	20 m	YES	PA12B2T20NO-C2	PA12B2T20NC-C2	PA12B2T20PO-C2	PA12B2T20NC-C2	PA12B2T20-C2
M12 mm Code 3	20 m	YES	PA12B3T20NO-C2	PA12B3T20NC-C2	PA12B3T20PO-C2	PA12B3T20NC-C2	PA12B3T20-C2

Note: Please order emitter and receiver separately

Specifications Emitter

Rated operational volt. (U _B)	10 to 30 VDC	Light source	LED, 880 nm
Ripple (U _{rip})	≤ 10%	Light type	Infrared, modulated
Supply current	≤ 20 mA	Optical angle	± 5°
Protection	Reverse polarity, transients	Power adjustment	50 - 100%, in 7 steps
Control input		R _x ~ 1.5 kΩ -10 kΩ	
Normal oper.	> 1.5 VDC		
Mute	< 1.2 VDC		

Specifications Receiver

Rated operating dist. (S_n)	20 m	Optical angle	± 5°
Blind zone	None	OFF-state current (I_r)	≤ 100 µA
Temperature drift	≤ 0.4%/°C	Voltage drop (U_d)	≤ 1.6 VDC @ 100 mA
Hysteresis (H)	3 - 20%	Protection	Short-circuit, reverse polarity, transients
Rated operational volt. (U_B)	10 to 30 VDC (ripple included)	Operating frequency (f)	30 Hz
Ripple (U_{rrp})	≤ 10%	Response time	OFF-ON (t _{ON}) ≈ 10 ms ON-OFF (t _{OFF}) ≈ 20 ms
Output current		Power ON delay (t_v)	≤ 300 ms
Continuous (I _e)	≤ 100 mA	Output function	Make or break (NO or NC)
Short-time (I)	≤ 100 mA, (max. load capacity 100 nF)	NPN or PNP	
No load supply current (I_o)	≤ 13 mA		
Minimum operational current (I_m)	0.5 mA		
Ambient light	>20.000 LUX		

General Specifications

Environment		Rated insulation voltage	50 VDC
Overvoltage category	II (IEC 60664/60664A, 60947-1)	Housing material	M12-Stainless Steel PC black
Pollution degree	3 (IEC 60664/60664A, 60947-1)	Body	
Degree of protection	IP 67 (IEC 60529, 60947-1)	Front	
Temperature		Connection	Cable PVC, grey, 5 m, 3 x 0.12 mm ² , Ø 3.2 mm
Operating	-20° to +50°C (-4° to +122°F)	Weight	
Storage	-25° to +80°C (-13° to +176°F)	Emitter	90 g
Vibration	10 to 150 Hz, 0.5 mm/7.5 g (IEC 60068-2-6)	Receiver	90 g
Shock	2 x 1 m & 100 x 0.5 m (IEC 60068-2-32)	CE-marking	EN12445, EN12453, EN12978
		Approval	UL508 and UL325

Operation Diagram

t_v = Power ON delay

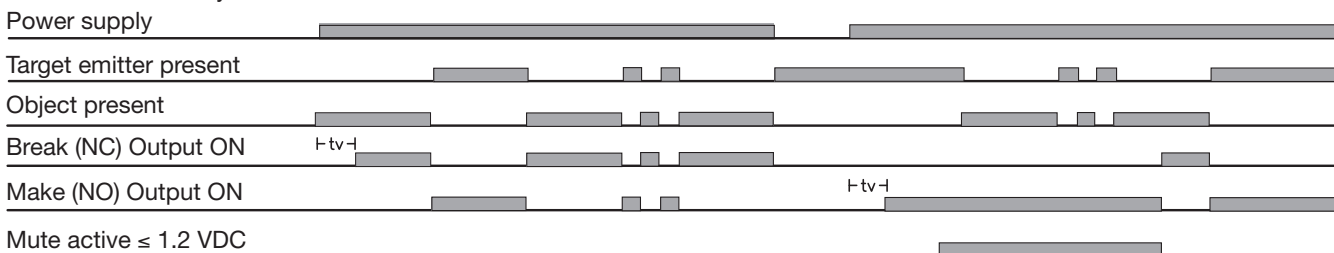

Installation Hints

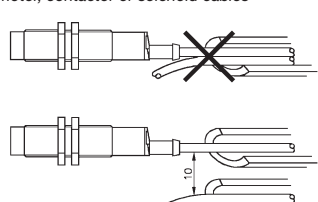
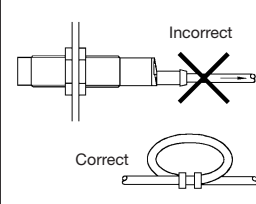
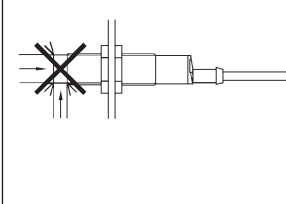
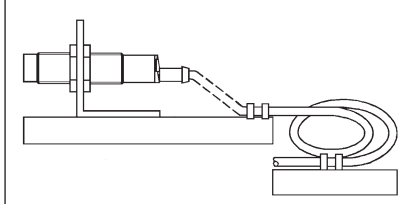
<p>To avoid interference from inductive voltage/current peaks, separate the prox. switch power cables from any other power cables, e.g. motor, contactor or solenoid cables</p> 	<p>Relief of cable strain</p>  <p>The cable should not be pulled</p>	<p>Protection of the sensing face</p>  <p>A proximity switch should not serve as mechanical stop</p>	<p>Switch mounted on mobile carrier</p>  <p>Any repetitive flexing of the cable should be avoided</p>
--	---	---	--

Dimensions

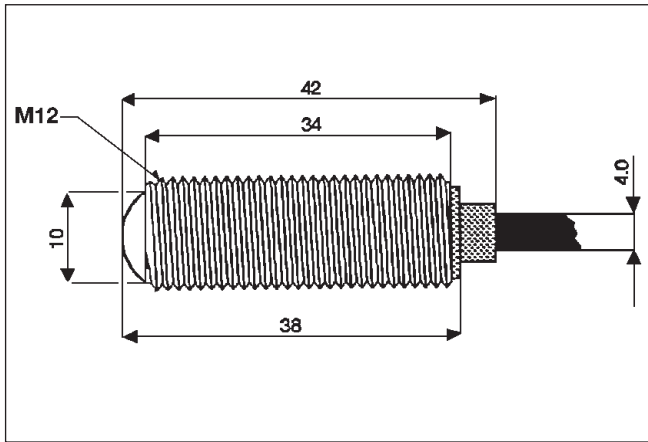

Detection Diagram

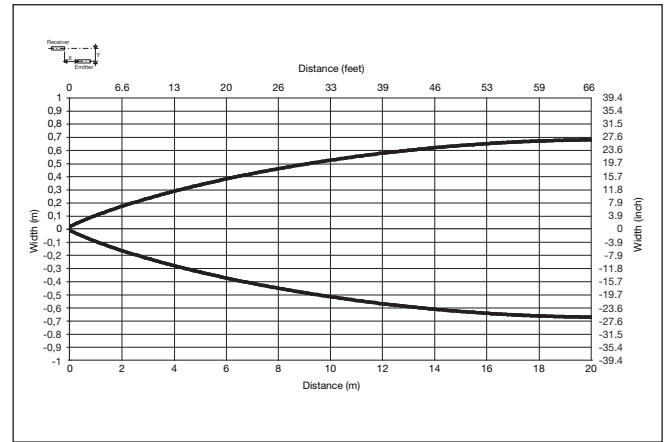

Wiring Diagram

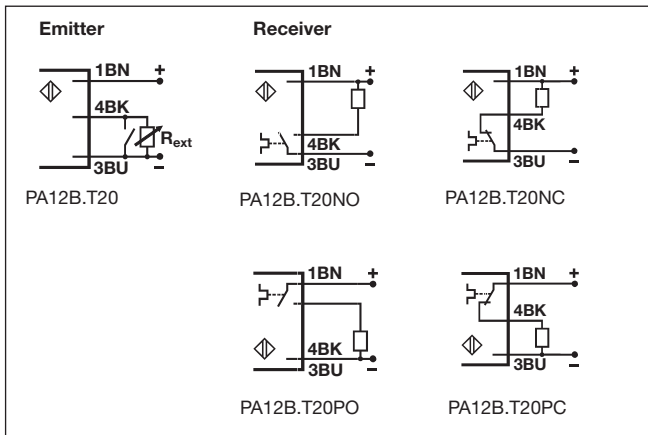

Excess Gain

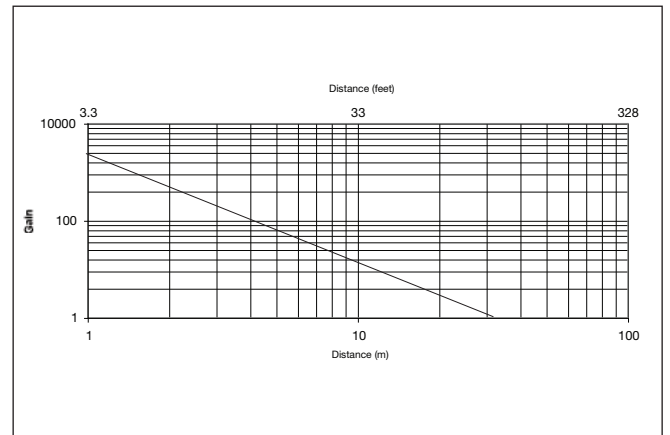

Neighbour Immunity Diagram

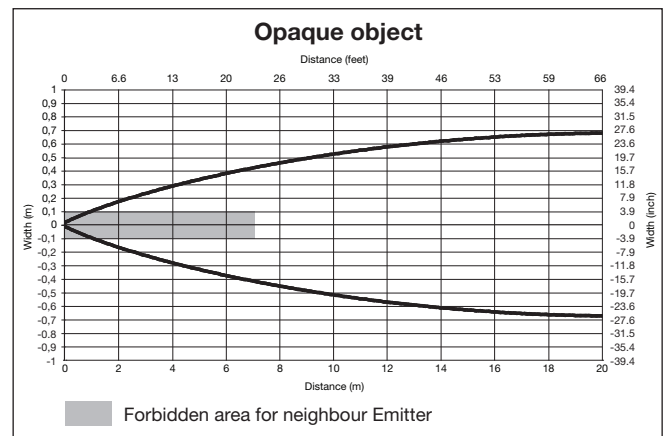
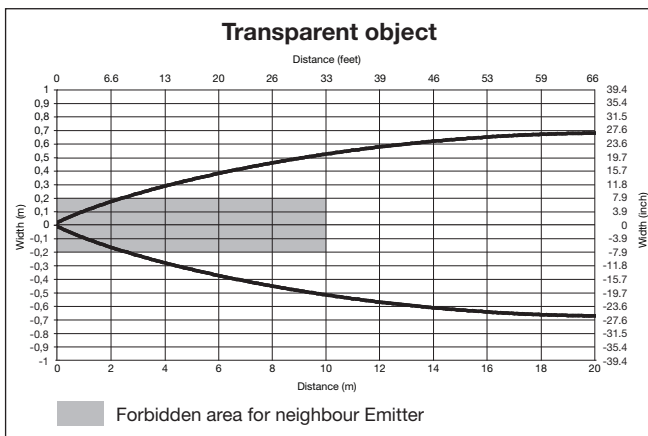

Mute Function

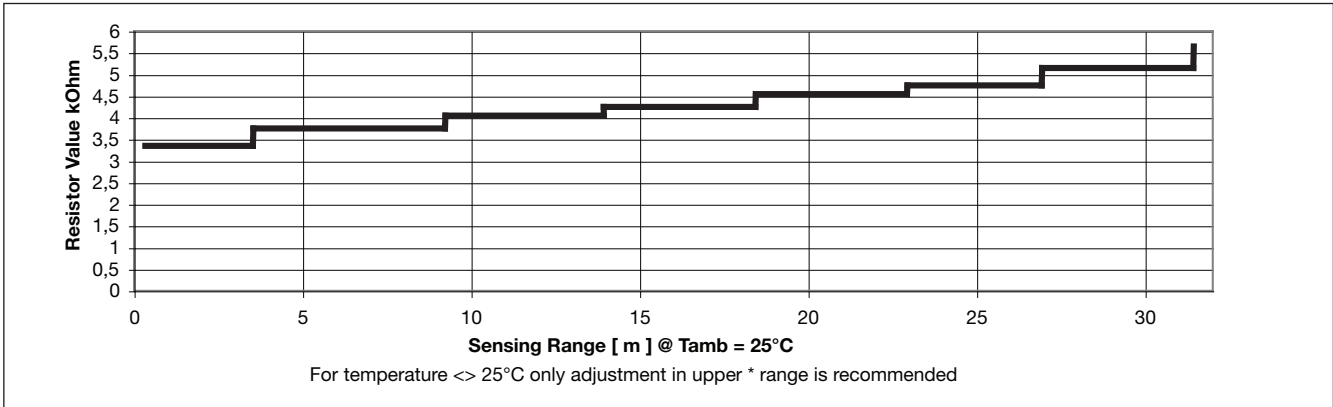

Delivery Contents

- PA12
- Installation instruction
- **Packaging:** plastic bag